



CREATIVE CONTROLS

SMART LIGHTING • SEAMLESS LIVING

DUBAI, UAE

> www.creativecontrols.ae

LED ALUMINIUM
PROFILE

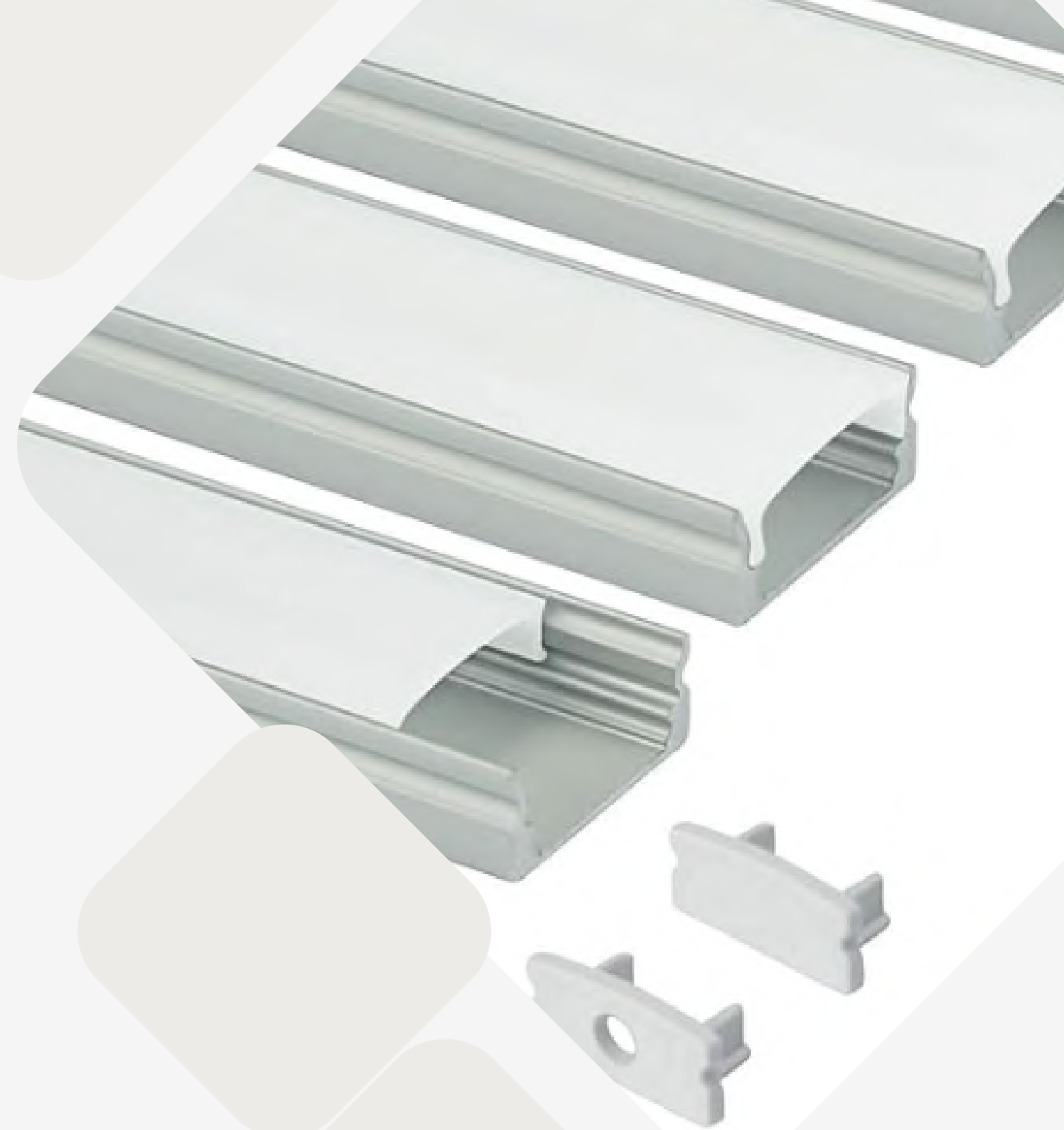

CC 60/70

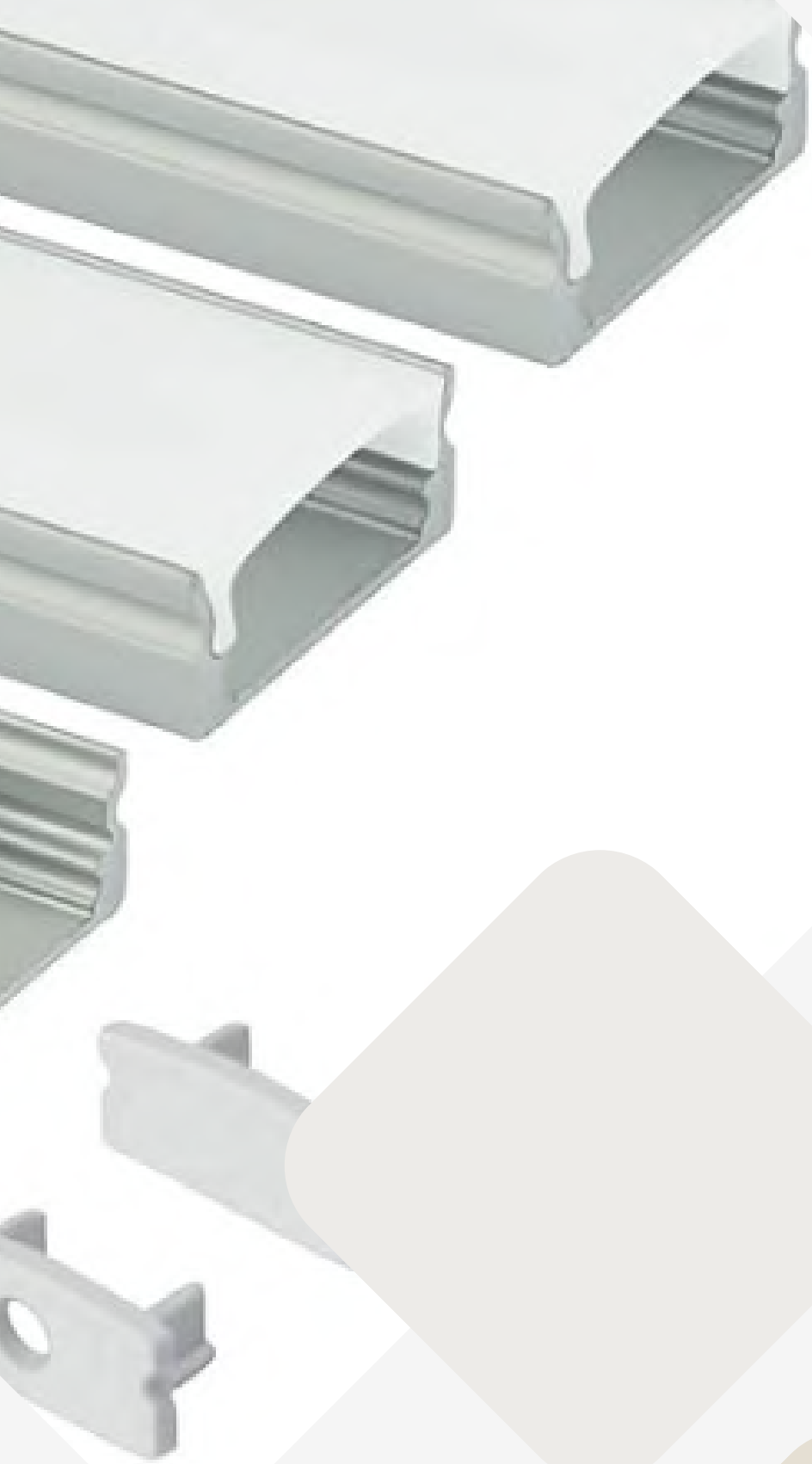

INTRODUCTION

LED lighting has revolutionized modern illumination with its energy efficiency, long lifespan, and compact form factor. As a versatile solution for residential, commercial, and architectural applications, LED strip lights offer flexibility in design and installation. To enhance performance and aesthetics, aluminum LED profiles (also known as LED channels or extrusions) provide a robust housing that supports heat dissipation, diffused light output, and a clean, finished look. Together, LED strips and profiles form a reliable, customizable lighting system suitable for linear lighting, accent lighting, and task lighting across diverse environments.

DIMENSIONS AND TECHNICAL DETAILS

DIMENSION

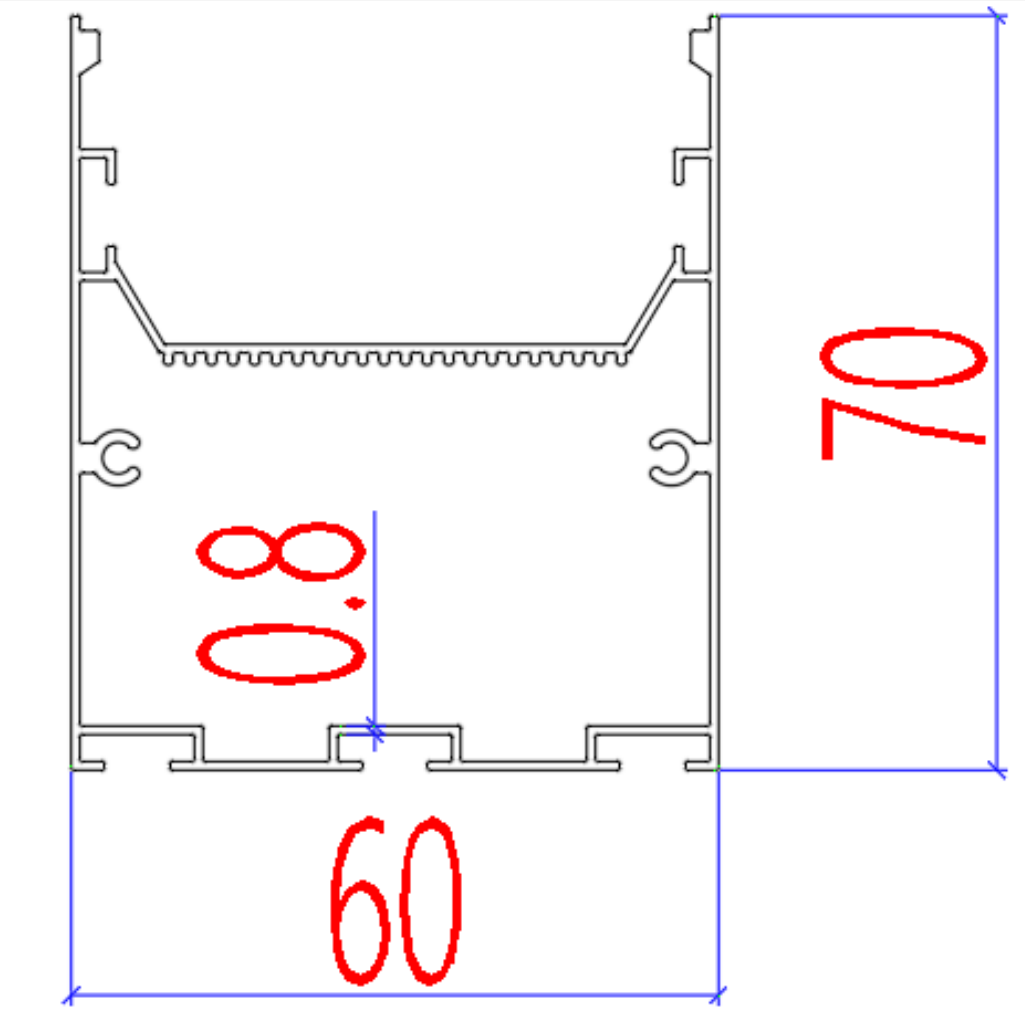

TECHNICAL DETAILS

Finish	Anodized Silver
Standard Length	2000mm
Max Length	2000mm
Accessories	End Caps 2 pcs/Mounting Brackets 4 pcs
Diffuser Option	Opal
Use	Indoor/ Outdoor

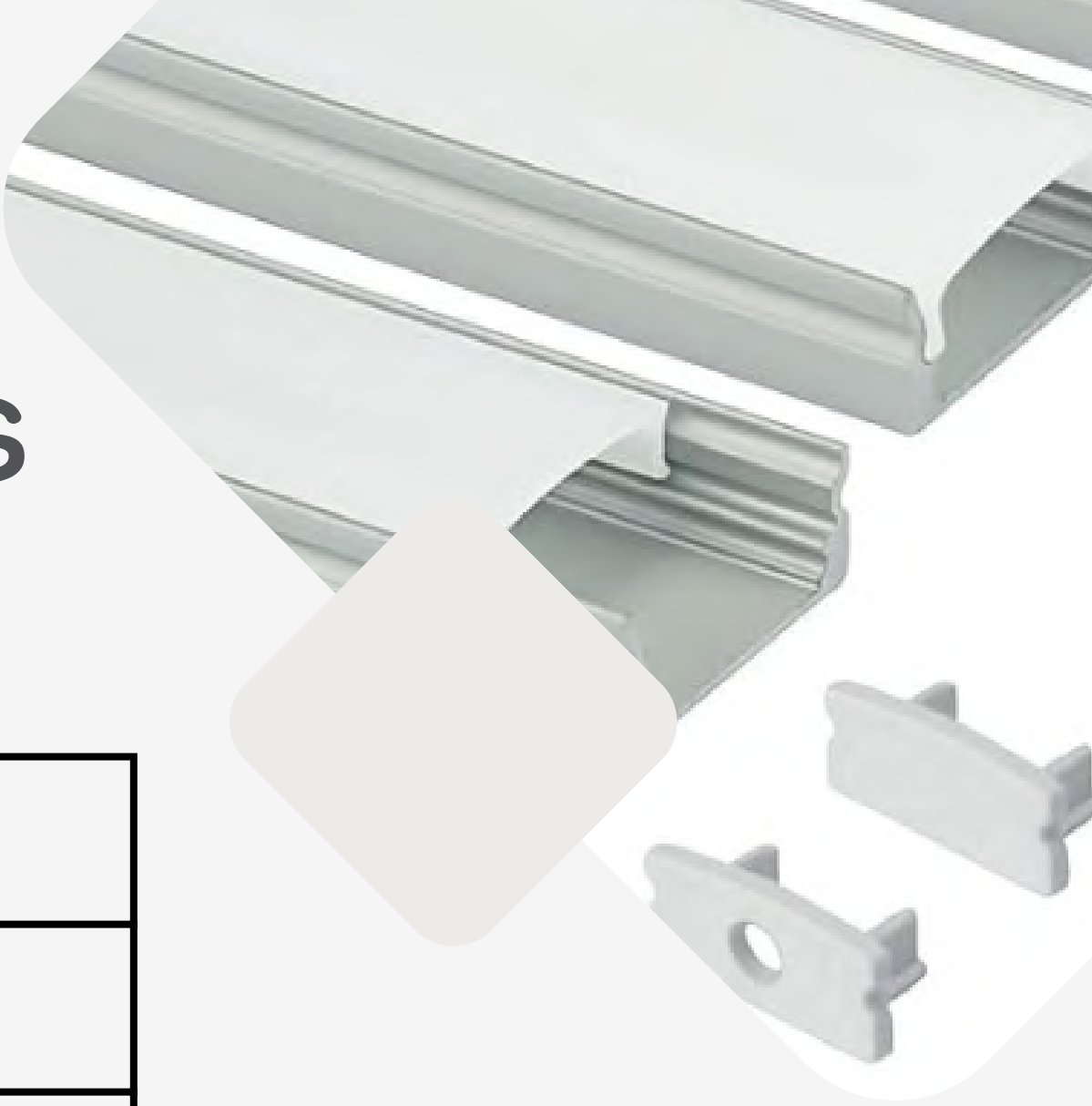

PRODUCT PORTFOLIO



DIFFUSER

A polycarbonate diffuser is a light-diffusing component made from polycarbonate resin, designed to spread light evenly from LED sources while offering durability and impact resistance. It is ideal for demanding environments where strength and heat resistance are critical.

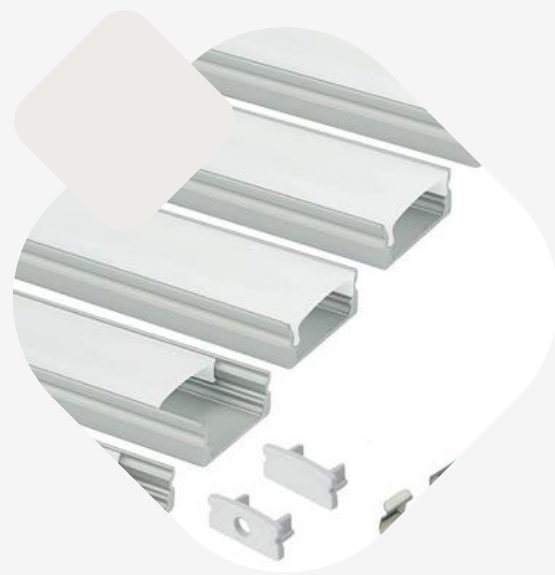

ANODIZED ALUMINIUM

Anodized aluminum is the preferred material for LED profiles (also called channels or housings) due to its lightweight strength, excellent heat dissipation, and refined appearance. The anodization process enhances corrosion resistance and surface durability, making it ideal for long-lasting and visually appealing LED installations.



PRODUCT DETAILS

INNOVATIVE DESIGN

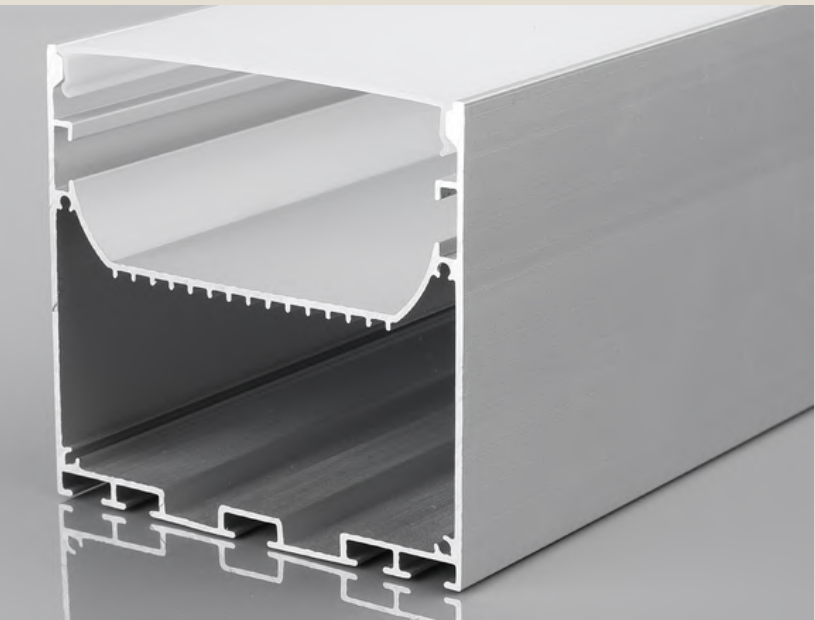

ITEM CC 60/70

We use carefully selected high-quality materials such as Aluminum and Diffuser ensure the strength, durability, and beauty of our products.

PACKING

Aluminum in Box	Diffuser in Box
100pcs * 2 m 200m	100pcs * 2m 200m

PROPERTIES OF RESIN

LEXAN (PC) resin frosted is a non-filled, extricable grade. This non-chlorinated, non-brominated flame retardant PC has an UL-94 V0 rating at 1.0 mm / 5VA rating at 3.0mm and is UV stabilized (F1 rating) providing additional weathering capability. Your paragraph text

TYPICAL PROPERTIES ¹	TYPICAL VALUE	Unit	Standard
MECHANICAL			
Tensile Stress, yld, Type I, 50 mm/min	630	kgf/cm ²	ASTM D 638
Tensile Stress, brk, Type I, 50 mm/min	610	kgf/cm ²	ASTM D 638
Tensile Strain, yld, Type I, 50 mm/min	7	%	ASTM D 638
Tensile Strain, brk, Type I, 50 mm/min	91	%	ASTM D 638
Tensile Modulus, 50 mm/min	23400	kgf/cm ²	ASTM D 638
Flexural Stress, yld, 1.3 mm/min, 50 mm span	990	kgf/cm ²	ASTM D 790
Flexural Modulus, 1.3 mm/min, 50 mm span	24100	kgf/cm ²	ASTM D 790
IMPACT			
Izod Impact, notched, 23°C	84	cm-kgf/cm	ASTM D 256
Izod Impact, notched, -30°C	11	cm-kgf/cm	ASTM D 256
Instrumented Impact Energy @ peak, 23°C	734	cm-kgf	ASTM D 3763
THERMAL			
Vicat Softening Temp, Rate B/50	145	°C	ASTM D 1525
HDT, 0.45 MPa, 6.4 mm, unannealed	141	°C	ASTM D 648
HDT, 1.82 MPa, 6.4 mm, unannealed	127	°C	ASTM D 648
CTE, -40°C to 40°C, flow	6.6E-05	1/°C	ASTM E 831
CTE, -40°C to 40°C, xflow	6.7E-05	1/°C	ASTM E 831
PHYSICAL			
Specific Gravity	1.2	-	ASTM D 792
Density	1.2	g/cm ³	ASTM D 792
Mold Shrinkage, flow, 3.2 mm (5)	0.6 - 0.9	%	SABIC Method
Melt Flow Rate, 300°C/1.2 kgf	3.2	g/10 min	ASTM D 1238